

EXHIBIT OF ROADWAY EASEMENT BEING A PART OF LOT 1, OF COMMUNITY GARDENS PLAT BOOK 43, PAGE 47 V.M.S. 978, PLEASANT TOWNSHIP, FRANKLIN COUNTY, OHIO



GRID NORTH



SCALE IN FEET

Course	Bearing	Distance
L1	N12°18'48"E	158.82'
L2	Rad: 305.49' Chd: N03°42'38"E	Δ: 17°12'22" 91.40'
L3	N04°53'33"W	286.05'
L4	Rad: 208.27' Chd: N24°22'10"W	Δ: 38°57'13" 138.89'
L5	N43°50'46"W	251.45'
L6	Rad: 337.61' Chd: N31°48'18"W	Δ: 24°04'55" 140.86'
L7	N19°45'51"W	5.00'
L8	N70°14'09"E	50.00'
L9	S19°45'51"E	5.00'
L10	Rad: 287.61' Chd: S31°48'18"E	Δ: 24°04'55" 120.00'
L11	S43°50'46"E	251.45'
L12	Rad: 258.27' Chd: S24°22'10"E	Δ: 38°57'13" 172.23'
L13	S04°53'33"E	286.05'
L14	Rad: 355.49' Chd: S03°42'38"W	Δ: 17°12'22" 106.35'
L15	S12°18'48"W	158.82'
L16	N77°41'12"W	50.00'

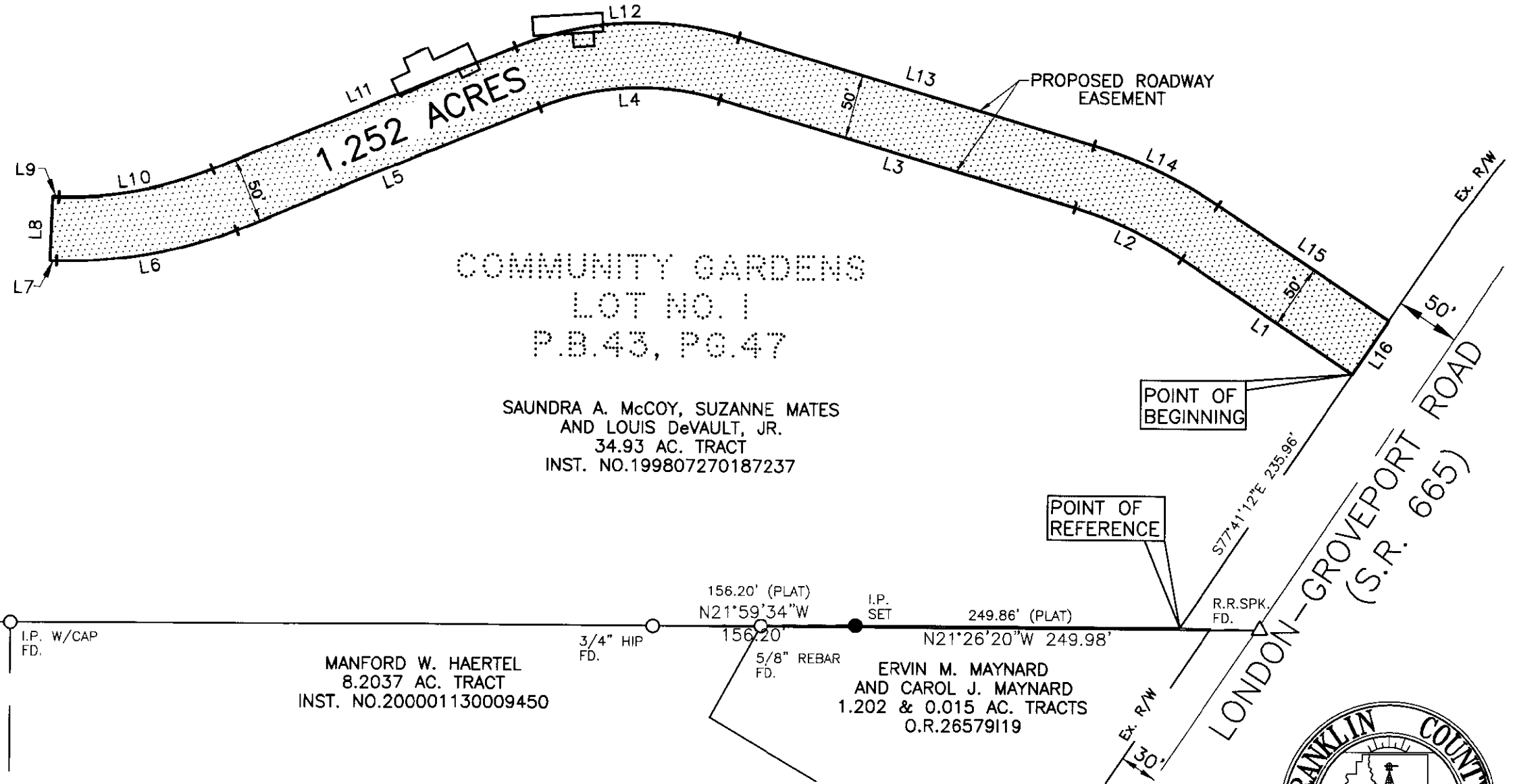

SAUNDRA A. McCOY, SUZANNE MATES
AND LOUIS DeVAULT, JR.
34.93 AC. TRACT
INST. NO. 199807270187237

HARRY B. WOTRING AND
MOLLY A. WOTRING
6.541 AC. TRACT
O.R. 3023H13

MANFORD W. HAERTEL
8.2037 AC. TRACT
INST. NO. 200001130009450

ERVIN M. MAYNARD
AND CAROL J. MAYNARD
1.202 & 0.015 AC. TRACTS
O.R. 26579119

BASIS OF BEARINGS:

BEARINGS ARE BASED ON THE OHIO STATE PLANE COORDINATE SYSTEM, SOUTH ZONE AND NORTH AMERICAN DATUM OF 1983, (1986), AS ESTABLISHED FROM FRANKLIN COUNTY GEODETIC CONTROL MONUMENTS "FRANK 19" AND "FRANK 119".

THIS PLAT WAS PREPARED FROM AN ACTUAL FIELD SURVEY PERFORMED IN MARCH, 2002 BY THE FRANKLIN COUNTY ENGINEER'S OFFICE, ALONG WITH PUBLIC RECORDS ON FILE IN THE FRANKLIN COUNTY RECORDER'S OFFICE AND THE FRANKLIN COUNTY ENGINEER'S OFFICE



David L. Pearson

DAVID L. PEARSON
OHIO REGISTERED SURVEYOR NO. 7298

5/21/2002

DATE

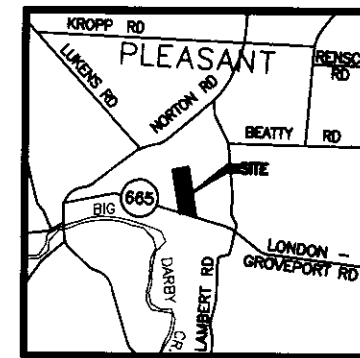

SITE MAP
SCALE: NONE

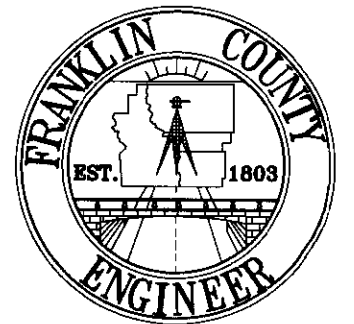

DATE: 05-21-02		DRAWING: WWTP-RD-EASE	
		DRAWN BY: DKT	
REVISIONS			
DATE	DESCRIPTION	BY	

SURVEY OF A 13.948 ACRE TRACT, BEING A PART OF LOT 1, OF COMMUNITY GARDENS PLAT BOOK 43, PAGE 47 V.M.S. 978, PLEASANT TOWNSHIP, FRANKLIN COUNTY, OHIO

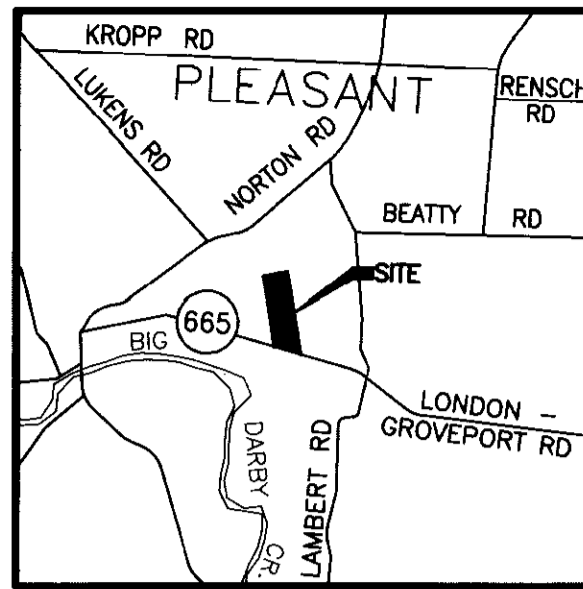

SITE MAP
SCALE: NONE

JOANN HOBSON
18.613 AC. TRACT
O.R.31106D16

GAYLE SCOTT, JR.
40.7947 AC. TRACT
O.R.6774H10

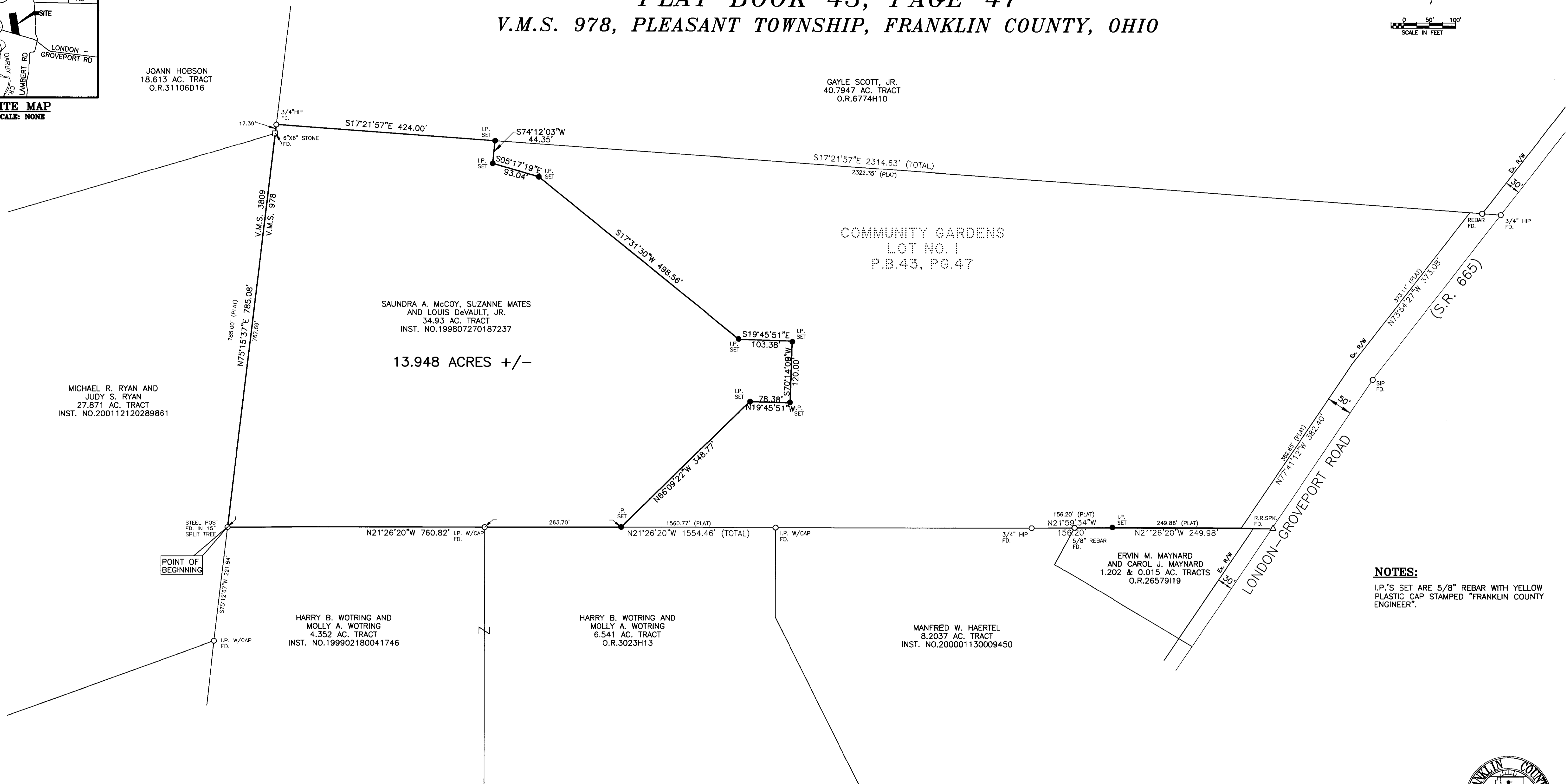
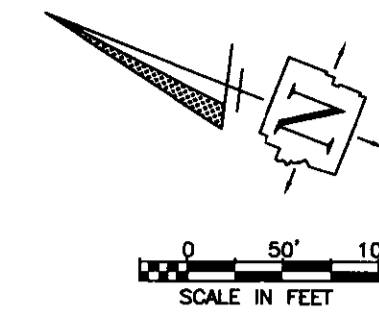

SAUNDRA A. McCOY, SUZANNE MATES
AND LOUIS DeVAULT, JR.
34.93 AC. TRACT
INST. NO.199807270187237

13.948 ACRES +/-

MICHAEL R. RYAN AND
JUDY S. RYAN
27.871 AC. TRACT
INST. NO.200112120289861

HARRY B. WOTRING AND
MOLLY A. WOTRING
4.352 AC. TRACT
INST. NO.199902180041746

HARRY B. WOTRING AND
MOLLY A. WOTRING
6.541 AC. TRACT
O.R.3023H13

MANFRED W. HAERTEL
8.2037 AC. TRACT
INST. NO.200001130009450

ERVIN M. MAYNARD
AND CAROL J. MAYNARD
1.202 & 0.015 AC. TRACTS
O.R.26579I19

NOTES:
I.P.'S SET ARE 5/8" REBAR WITH YELLOW
PLASTIC CAP STAMPED "FRANKLIN COUNTY
ENGINEER".

BASIS OF BEARINGS:

BEARINGS ARE BASED ON THE OHIO STATE PLANE COORDINATE SYSTEM, SOUTH ZONE AND NORTH AMERICAN DATUM OF 1983, (1986), AS ESTABLISHED FROM FRANKLIN COUNTY GEODETIC CONTROL MONUMENTS "FRANK 19" AND "FRANK 119".

THIS PLAT WAS PREPARED FROM AN ACTUAL FIELD SURVEY PERFORMED IN MARCH, 2002 BY THE FRANKLIN COUNTY ENGINEER'S OFFICE, ALONG WITH PUBLIC RECORDS ON FILE IN THE FRANKLIN COUNTY RECORDER'S OFFICE AND THE FRANKLIN COUNTY ENGINEER'S OFFICE

David L. Pearson
DAVID L. PEARSON
OHIO REGISTERED SURVEYOR NO.7298

5/17/2002
DATE

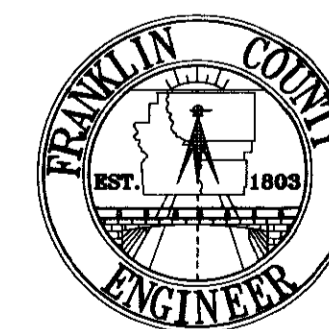

DATE: MAY 16, 2002	DRAWING: WWTP
	DRAWN BY: DKT
REVISIONS	
DATE	DESCRIPTION
3/03	REVISED BEARING & NAME